

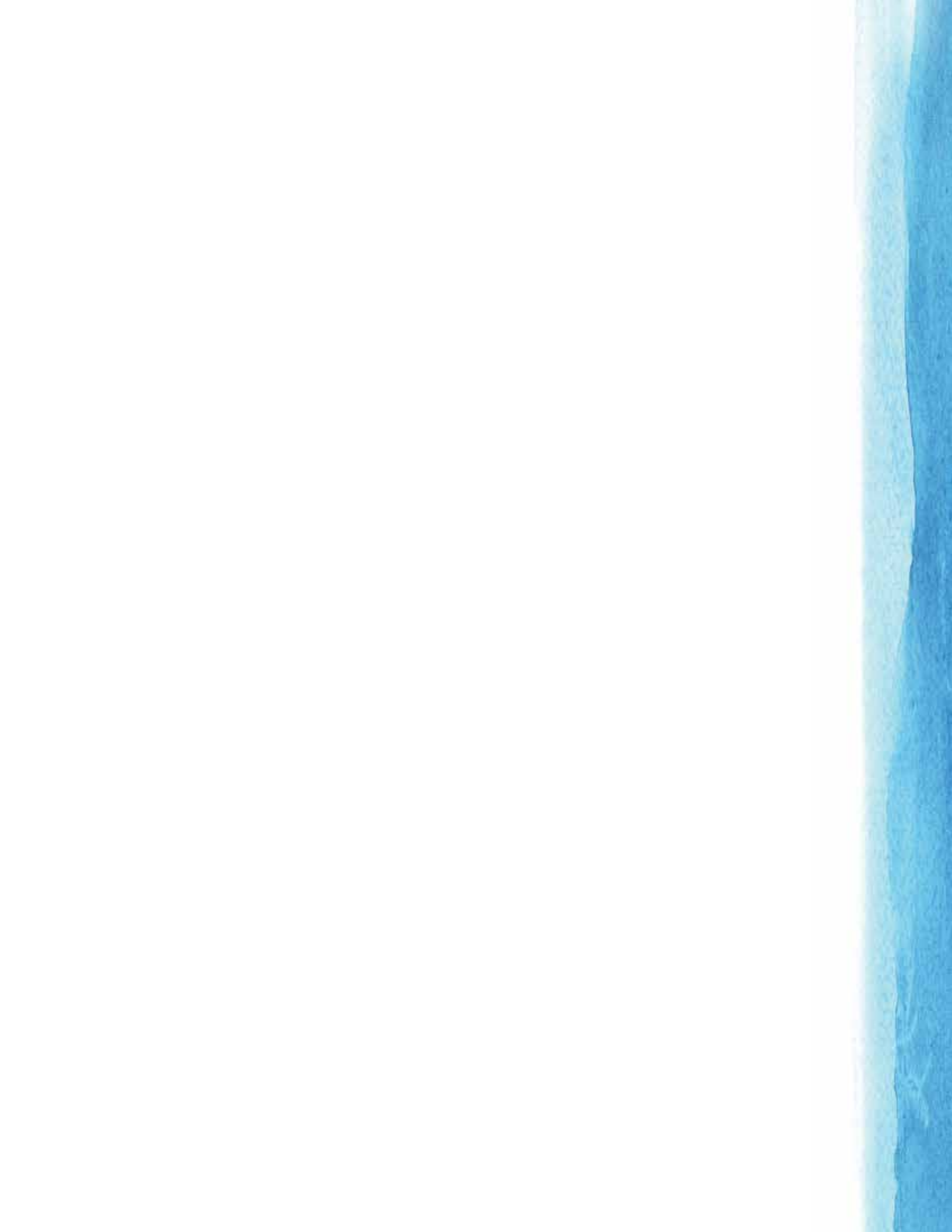

Handbook on Accessible Household Sanitation for Persons with Disabilities (PwDs)







Handbook on Accessible Household Sanitation for Persons with Disabilities (PwDs)

MINISTRY OF DRINKING WATER & SANITATION
SWACHH BHARAT MISSION (GRAMIN)
GOVERNMENT OF INDIA
December 2015

Photo credits

Cover photo: WaterAid/Guilhem Alandry

Page 8, clockwise from top extreme right

WaterAid/Marco Betti

WaterAid/Marco Betti

WaterAid/Pragya Gupta

WaterAid/Sridevi Sunderarajan

WaterAid/Pragya Gupta

All other images:

WaterAid/Jane Wilbur

WaterAid/Hazel Jones

WaterAid/Sumantra Mukherjee

Abbreviations

AIP	Annual Implementation Plan
BPL	Below Poverty Level
CSO	Civil Society Organisation
CFT	Cubic feet
DFID	Department for International Development
DPO	Disabled People's Organisation
DWSD	District Water and Sanitation Department
DWSM	District Water and Sanitation Mission
GP	Gram Panchayat
MDWS	Ministry of Drinking Water and Sanitation
NGO	Non-Government Organisation
ODF	Open Defecation Free
PHED	Public Health Engineering Department
PIP	Project Implementation Plan
PRI	Panchayati Raj Institution
PWDs	Persons with Disabilities
RTE	Right to Education
SBM	Swachh Bharat Mission
VWSC	Village Water and Sanitation Committee
WSS	Water Supply and Sanitation
WASH	Water, Sanitation and Hygiene
WEDC	Water Engineering and Development Centre



बीरेन्द्र सिंह
Birender Singh



ग्रामीण विकास, पंचायती राज और
पेयजल एवं स्वच्छता मंत्री
भारत सरकार

MINISTER OF RURAL DEVELOPMENT,
PANCHAYATI RAJ AND
DRINKING WATER & SANITATION
GOVERNMENT OF INDIA



MESSAGE

Our government is committed to sanitation for all, everywhere and always. This needs to be a nationwide movement with the participation and involvement of all.

In order to ensure barrier-free access to sanitation in consonance with the provisions of the "Persons with Disabilities (Equal Opportunities, Protection of Rights and Full Participation) Act, 1995 enacted by the Parliament on January 1, 1996", the Ministry of Drinking Water and Sanitation (MDWS), Government of India, has factored the sanitation needs of persons with disabilities to be supported under the Swachh Bharat Mission (Gramin) guidelines.

There are building standards specified by Government of India for the built environment in schools, public buildings and institutions. But individual toilets are in the domain of the households and the family and need to be customised as per the needs and demands of the households.

With this aim to ensure that everyone, including the physically disabled and elderly persons, will have unhindered access to household toilets, comprehensive user guidelines, spaces and design norms are being suggested for accessible toilets which can be used by disabled persons, elderly persons and pregnant women,

It is my pleasure to introduce "**The handbook on accessible household sanitation for persons with disabilities**". This handbook can be used as a supporting document to the Swachh Bharat Mission (Gramin) Guidelines, 2014 and the Technical Manual on Household Toilets Options, 2010. The primary objective of this book is to frame guidelines for non-ambulant (chair bound), semi ambulant (lower limb impairment) and visual disability (partial and full blindness).

This will assist planners, implementers at district and block level, elected representatives, functionaries of gram panchayat level and households on basic accessibility principles and appropriate designs.

I would request elected representatives, government functionaries of gram panchayats, block and district level officials and engineers implementing rural sanitation programmes, NGOs and disabled people's organisations involved in the Swachh Bharat Mission to refer to this book often and discuss also with other relevant stakeholders.

I would urge State Drinking Water and Sanitation Departments, State Rural Development and Panchayati Raj Departments and State Institutes of Rural Development to translate this book in their respective state language and also make state specific changes where necessary. I welcome all to share and disseminate the information in this book as much as possible.

(BIRENDER SINGH)





राम कृपाल यादव
Ram Kripal Yadav

राज्य मंत्री
पेयजल एवं स्वच्छता मंत्रालय
भारत सरकार



MINISTER OF STATE
DRINKING WATER & SANITATION
GOVERNMENT OF INDIA

MESSAGE

“The Handbook on accessible household sanitation for persons ‘with disabilities’ is designed for use by functionaries for planning and designing rural sanitation interventions and also working directly with communities like rural sanitation engineers, PRI members, swachh-tadoots, NGO functionaries, block and district officials, including health workers and community volunteers working with disabled and older people and their families in rural areas of India.

This handbook is the result of a series of consultations with stakeholders from both disability as well as water and sanitation sectors (Government functionaries, NGO staff, disabled people’s organisations, persons with disabilities, institutions and international agencies addressing water and sanitation or/and disability) working at the district level, state and national levels over a period of two years. The process of developing it was led by Ministry of Drinking Water and Sanitation, Government of India and Water Aid with support from Water Engineering and Development Centre (WEDC), Loughborough University, Drinking Water and Sanitation Department, Government of Jharkhand and DFID.

A few examples of household sanitation designs are presented here which families can adapt to suit their needs and budgets. These designs have been implemented in Jharkhand by Water and Sanitation Department, Government of Jharkhand, Water Aid partners in consultation with disabled people organisations and the disabled persons themselves. While certain models have been featured in this book, many more options are possible and can be explored.

I understand that most of the ideas in this handbook are suitable for disabled people but are not only for them. As we get older, many of us find it increasingly difficult to squat and balance, or we might be injured or sick. Some of these designs can also be used by pregnant women who need support in squatting and in getting up. These designs might also make facilities easier and more comfortable to use by everyone in the family.

I believe that this book can be used in various ways: as a starting point for discussion with households, as a way of encouraging communities to consider design options, by disabled people’s organisations, as image flash cards or as posters.

I appreciate the efforts of the Ministry of Drinking Water and Sanitation for releasing this handbook with the support of Water Aid, India. This book is a first of its kind and can be used as a guide and to trigger ideas. This is dynamic and will be updated as more ideas and examples come in.

Ram Kripal Yadav
(Ram-Kripal Yadav)



Introduction

Government of India has made proactive legislation to address the need of basic services for persons with disability. India is a signatory to the Declaration on the Full Participation and Equality of People with Disabilities in the Asia Pacific Region. India is also a signatory to the Biwako Millennium Framework for action towards an inclusive, barrier free and rights based society. India signed the UN Convention on Protection and Promotion of the Rights and Dignity of Persons with Disabilities on 30th March, 2007, the day it opened for signature. India ratified the UN Convention on 1st October, 2008.

Much before the UN Convention, under Article 253 of the Constitution, the Government of India enacted "The Persons with Disabilities (Equal Opportunities, Protection of Rights and Full Participation) Act, 1995", in the effort to ensure equal opportunities for persons with disabilities and their full participation in nation-building. The Act extends to the whole of India except the State of Jammu and Kashmir. The Government of Jammu & Kashmir has enacted "The Persons with Disabilities (Equal Opportunities, Protection of Rights & Full Participation) Act, 1998". The Constitution of India ensures equality, freedom,

justice and dignity of all individuals and implicitly mandates an inclusive society for all including the persons with disabilities. The Constitution in the schedule of subjects lays direct responsibility of the empowerment of the persons with disabilities on the State Governments therefore, the primary responsibility to empower the persons with disability rests with the State Governments.

A multi-sectoral collaborative approach, involving all the appropriate Governments i.e. Ministries of the Central Government, the State Governments/UTs, Central/State undertakings, local authorities and other appropriate authorities is being followed in implementation of various provisions of the Act.

The Ministry of Drinking Water and Sanitation (MDWS) apart from substantially increasing the Government assistance for household toilets has also broadened the eligibility beyond BPL1 categories to firmly include households having Persons with Disabilities (PwDs). The new Swachh Bharat Mission (Gramin) while focusing on universal sanitation coverage is also looking at better ways of addressing needs of Persons with Disabilities.

Why a handbook for accessible design options for PwDs

In spite of the enabling policies and guidelines at national and state level, there has been challenges faced by implementers and service providers because of a lack of appropriate and cost effective technology options which are PwD friendly, lack of skills to deal with PwDs, absence of adequate information on inclusive toilet designs not reaching the district and block functionaries, inherent existing challenges in inter-sectoral coordination and lack of skilled NGOs.

- Improved knowledge and awareness of communities on disability and barriers to access
- Inclusion of PwDs in decision making processes including platforms like the village water and sanitation committees, parent teacher associations and school management committees
- Improved capacities of service providers (including PHED functionaries), local government institutions, disabled people's organisations and CSOs to address inclusive and accessible WASH programming at households, communities and institutions level
- Barrier free accessible and cost effective models in WASH for PwDs which can inform inclusive WASH costing in government programmes leading to a menu of accessible technical options to address barrier free sanitation access for PwDs in households

Rationale for accessible design options for PwDs

- **Benefits of inclusive facilities.** Many people, such as the elderly, pregnant women, girls, parents with small children and people who are injured or sick may have difficulty with balance,

co-ordination, weak grip, squatting or lifting. Because of this they experience many of the same problems as disabled people, although they are not described in this way. Inclusive planning of water and sanitation services therefore benefits the whole community, and often involves only minor adjustments to ordinary services.

- **Cost effectiveness.** It is cost effective and cheaper to plan from the outset to make services inclusive for disabled people, than to provide add on special services which only a small minority benefit from. The most cost-effective way to improve access for children with disabilities is to incorporate accessibility into the design from the outset (inclusive design) rather than making expensive changes later.
- **Environment factors.** However well designed the latrine, other factors such as location, distance and approach path affect accessibility and need to be a part of planning and design.

Technical options in this booklet will address the needs of:

- Primary users in communities: Persons with disabilities - Persons with visual disability and locomotor disability including pregnant women and senior citizens/ older people.

Who can use the handbook?

This handbook can be used by Government functionaries, water and sanitation engineers, representatives of Panchayati Raj Institutions, WASH sector professionals, disabled people's organisations and disability service providers, and organisations representing or working with other socially excluded groups. This handbook is expected to serve as a practical guide and have a better understanding of:

- The problems facing disabled people, elderly people and other vulnerable groups in accessing water, hygiene and sanitation facilities
- Challenges facing the sanitation sector in serving vulnerable groups and persons with disabilities
- Possible solutions to address these issues under Swachh Bharat Mission (Gramin)

How to use the handbook?

This handbook can be used in various ways:

- As a starting point for discussion with households
- As a way of encouraging communities to consider design options
- By disabled people's organisations
- Capacity building of government and NGO functionaries implementing Swachh Bharat Mission (Gramin)
- As flashcards - images can be enlarged and stuck on card
- As posters - images can be printed and used for group discussions

Capacity building

- Training for district level engineers, NGOs and PRIs on barriers to access and accessible solutions
- Training on conducting accessible audits
- Improve knowledge of sanitation and hygiene among DPOs so that they can advocate more effectively

- Improve knowledge of disabled people about how sanitation facilities can be adapted to meet their needs

Technical specifications are not given beyond the designs piloted and shared here, because all dimensions should be based on users' needs.

The aim is to provide as much 'independent access' as possible - this means facilities that a person can use without help, or with minimum help. If possible, try out ideas first to work out: how high a seat or support rail should be? How wide the entrance should be? To work out how much space is needed inside a latrine, mark out the area on the ground using rocks or branches. Ask different users to try moving and squatting/sitting inside, and adjust if necessary.

Costs and materials itemised here are purely suggestive and serve as examples because they will vary between communities and states.

Actions at state and district level

- "Key functionaries at the state and district level to take part in a participatory barrier analysis (see "Who can use the handbook" on page 10).
- Key functionaries at district and block level to meet representatives from disabled people's organisations, and from the health, education, aging and WASH sectors.
- Key functionaries from the district and state level to take part in accessibility and safety audits within the community, or at any venue where meetings are being held.
- District Annual Implementation Plans to include targets on improving access and use for everyone in planning, budgeting, and monitoring.

- Include access and use by disabled people as a criteria of ODF in national ODF verification protocols.
- District Water Supply and Sanitation functionaries and DPOs collaborate and coordinate their activities to improve service delivery.
- Bring the issues into the public realm through publications, mass media, meetings and events. Use available data on the topic from interviews with different people, insights from change stories, accessibility audits and the participatory barrier analysis.
- Include accessible sanitation designs in national standards and protocols.

Actions at village and panchayat level

This set of actions is meant for Swachhata doots, village/GP level motivators, PRIs, WARD members and NGOs working at the village and panchayat level.

When arranging VWSC meetings:

- Ensure meeting times are convenient for both women and men (e.g. not during meal preparation).
- Agree locations of meetings to be close to homes of the least mobile, and in buildings without steps.
- Take care that disabled and older people are not pushed to the back of meetings and arrangements are made for those with difficulty hearing or seeing to be near the front.
- If visual media are used, ensure they are described verbally to those with difficulty seeing, and verbal presentations supplemented with visuals for those with difficulty hearing.

When arranging additional meetings:

- Consider separate group discussions with people who may feel unable to speak in community meetings.
- Visit disabled or older people who cannot attend meetings in their homes to ensure their concerns are not ignored.
- Share issues raised in these additional meetings with the wider community or their selected representatives.

When arranging meetings with disabled people: (CLTS approach to trigger sanitation demand)

At any time:

- Ask people with disabilities what problems they face and how these might be overcome.
- Bring small groups of disabled people together to discuss their experiences with sanitation in a supportive group.
- Convene community meetings and encourage everyone to listen to what disabled people have to say.

Pre-triggering:

- Ask who in the community is disabled and whether they can come to the triggering.

Post-triggering follow up

- Suggest that disabled people are marked on the monitoring map.
- Facilitate participatory design to suit disabled people's needs. If necessary, feed in ideas.
- Encourage links between disabled people and those able and willing to support them.
- Make it known that arrangements for disabled

people are a part of verification.

Triggering

- Ask if disabled people can be marked on the map.
- Encourage and support disabled people to speak up and be heard when plans are being made.

Verification

- Ask disabled people how they manage - Check that arrangements are adequate, within the means of the community.
- Post-ODF check on arrangements and encourage improvement.

How to implement accessible sanitation options

Consultation with disabled people

Consult on project design, technology options and staff training. Make sure to consult disabled women as well as disabled men. Disability service providers can also be a useful source of advice and skills

A. Identifying and understanding barriers to access

Purpose: To identify and analyse the barriers, obstacles and factors that create problems for users in accessing and using water and sanitation facilities.

Diversity message: Different groups of users may experience different problems and barriers when using facilities.

Engineering message: The way infrastructure is designed and built can unintentionally exclude some users.

The need for convenient access to sanitation and hygiene is stark and acute for many disabled, older and chronically ill people who have to defecate in their dwellings or in the open. In their homes there are problems of smell and disposal. In the open, people with visual impairments have to rely on a guide or make their own way with dangers of trampling shit.

Problems faced by people with a mobility impairment are similar, and if they move on all fours, risk getting filthy crawling among the shit (Wilbur 2010). If the toilets are dirty it is harder for disabled people to keep themselves clean, especially if they are blind. The dangers of getting dirty affect their health, degrade their self-esteem and can affect how others see and treat them. This can undermine their confidence and make them unwilling to express their needs .

Four types of barriers are:

Individual barriers are those attributes of an individual that make it difficult for them to access water and sanitation. For example,

- if someone is weak because of illness,
- is an older person with weak arms, legs or an injured back, is very short (child),
- or has limited mobility because of pregnancy.

These are barriers which might be addressed with interventions that focus on that limitation. For example, by providing a wheelchair for someone who cannot walk, drugs for someone who is sick, or a stick to help guide someone who cannot see.

These barriers are often the focus in the medical model of disability but **are not usually the focus** for WASH programmes.

Purpose: To identify and analyse the barriers, obstacles and factors that create problems for users in accessing and using water and sanitation facilities.

Diversity message: Different groups of users may experience different problems and barriers when using facilities.

Engineering message: The way infrastructure is designed and built can unintentionally exclude some users.

Environmental barriers are often easiest to identify. They include barriers to **physical access:**

- Long distances to facilities
- Paths that are rough or steep or no paths at all
- Toilets with high steps or narrow doors
- Inside, a lack of space
- Nothing to hold onto, or to raise oneself up from squatting
- Nothing to sit on for those who cannot squat
- Access issues are just as significant for those with sensory or communication impairments where information is not available in formats they can understand

Also think about the positioning of latrines – do they provide privacy and safety for girls?

Do they have to go through unsafe areas to get to water points?

How far do people have to travel?

Is the orientation of latrines important (for example, some religions do not want to face East)?

Institutional barriers are some of the most difficult to identify. Without a proactive search for them, they won't be as immediately evident. That's because they're often linked to social and cultural norms and written into policies and legislation.

Disabled, older or chronically ill people may:

- Be excluded by the way a programme or service is delivered
- Not hear about a meeting
- Not be able to reach it
- Not be invited or feel able to speak
- Have their opinions dismissed
- Lack of consultation and participation can then lead to inappropriate designs
- Design or location of facilities, overlooking their needs, and limiting or denying their access to sanitation. Addressing these barriers is crucial throughout the community mobilisation process
- Implementing staff often lack information about low-cost ways of making toilets accessible for disabled and older people. People themselves are often unaware of the options available, so they do not know how/what to ask for improvements (Jones and Reed 2005)

Attitudinal barriers are the most important to identify – time and time again they are the main reason prohibiting progress on inclusion of marginalised people. Negative attitudes and assumptions have led to many disabled people believing themselves to be worthless, independent and in need of support. Women are sometimes not respected as decision-makers or considered capable of technical skills and tasks.

People who are disabled may be discriminated against and not reported under surveys and older people, especially women, may be shunned by younger people.

B. Inclusive and accessible designing

1. Approaches to improving accessibility

- Design and construct facilities that are accessible for all
- Adapt and modify existing facilities to improve accessibility
- To provide assistive devices to individuals to enable them to access existing facilities

Preparatory work towards designing options:

- Become better acquainted with disabled people in the community to understand their personal challenges and work with them to develop appropriate solutions to making WATSAN services more accessible
- Examine current situation of disabled people's access to WATSAN and then review designs to make them more accessible
- Investigate solutions currently being implemented in the community and, where appropriate, incorporate them into future work
- Investigate improving specific features such as the design of taps to improve their accessibility to disabled people
- Identify key features that make facilities accessible and incorporate them into minimum standards
- Produce some practical demonstrations of accessible technology

2. Making facilities physically accessible

Getting there: Reaching facilities-

- paths
- ramps
- support rails
- landmarks for blind people

Getting in:

- thresholds
- wide entrance
- flat platform in front of door
- doors
- easy to close, lockable for privacy

Usability:

- hand pump aprons
- internal dimensions - extra space for wheelchair to enter and turn, user +helper, or to move a seat to one side
- support rails: fixed to the floor, adjustable height, movable frame, rope
- suspended from a beam overhead
- seating – fixed, movable
- design of equipment
- adapted water lifting mechanism

Reaching facilities –Paths

How to get there?

Suitable for: everyone, especially users with a visual impairment and with physical impairments, including wheelchair users



Construction	Advantages	Disadvantages	Improvements/variations
Guide string from house to latrine and bath shelter	<ul style="list-style-type: none"> Easy to construct Simple to maintain Suitable for users with visual impairment 	<ul style="list-style-type: none"> Regular maintenance needed String must be carefully positioned so it is not a hazard to other users 	<ul style="list-style-type: none"> Path could be lined with painted rocks or landmark posts
Clear, level path, lined with rocks	<ul style="list-style-type: none"> Can be made according to budget Suitable for users with visual and physical impairments, including wheelchair users 	<ul style="list-style-type: none"> Rocks are easily moved or dislodged, which could cause a trip hazard Maintenance would include regular re-positioning of the rocks 	<ul style="list-style-type: none"> Paint rocks white or a bright colour to increase visibility
Landmark posts made from local materials	<ul style="list-style-type: none"> Can be made according to budget Easy to construct using local materials Provides guidance for users with visual impairment 	<ul style="list-style-type: none"> Posts must be firm, and positioned so they are not a hazard to others Regular maintenance needed to check posts are stable 	<ul style="list-style-type: none"> Posts can be painted/ marked with a bright colour to increase visibility Use alternative materials, e.g. rocks, or existing features, e.g. trees

Ramps

Suitable for: Users with physical impairments, wheelchair users, older people, people carrying heavy loads



Construction	Advantages	Disadvantages	Improvements/variations
<p>Low-gradient concrete ramp with raised sides for safety (measurement 1:12 or more)</p>	<p>Smooth, firm, durable</p> <p>Gentle gradient so a child can propel her/himself up and make a controlled descent</p> <p>Raised sides prevent wheelchairs rolling off</p>	<p>Monitoring of construction required to ensure gradient not too steep</p> <p>Maintenance needed to keep the ground the same level as the end of the ramp</p>	<p>Paint raised sides white or bright colour to increase visibility</p>



Construction	Advantages	Disadvantages	Improvements/variatiions
<p>Wide concrete ramp to handpump apron</p>	<p>The concrete ramp onto the apron improves access for everyone</p>	<p>Ramp requires more space than steps</p> <p>Drainage must be in the opposite direction to keep the ramp dry</p> <p>Monitoring needed to ensure masons do not make it too steep to reduce cost</p>	<p>Paint raised sides white or a bright colour to increase visibility</p> <p>Cross-hatching on ramp would make it less slippery when wet (see page 21 'Steps')</p>



Construction	Advantages	Disadvantages	Improvements/variatioins
<p>Moveable wooden ramp for wheelchair to access facilities with steps</p>	<p>Flexible - can be placed wherever needed</p> <p>Cheaper than concrete</p> <p>Raised sides prevent a wheelchair rolling off the side of the ramp</p>	<p>Less durable than concrete</p> <p>User needs help to move the ramp when needed</p>	<p>Paint raised sides white or bright colour to increase visibility</p>

How gradient slope of a ramp is measured

“Gradient” describes the change in height over a specified distance.



Example : Gradient 1 : 15

This slope rises 1 unit over a distance of 15 units. If the distance is 15m, the slope will rise 1m.

1:20 is ideal but would require a lot of space. So as a good middle path 1:15 can be done. Certain Indian specifications recommend 1:12m – This is fairly steep but this is the absolute minimum and the ratio should not go below this.

Depending on the space available, a ramp may be designed as a "Straight Ramp" or "Switch back Ramp". The following should be the features/ dimensions of a ramp as per the Universal design concept.

A Ramp should be smooth, non-slippery, firm and stable and made of a material that is not likely to wear away quickly.

A landing may be provided for resting at every vertical rise of 750mm and also between two flights of a ramp for easy movement. Besides the rest area, it is also required in places where the ramp changes direction.

Steps

Suitable for: steep terrain; where space is limited; households or communities with no wheelchair users.

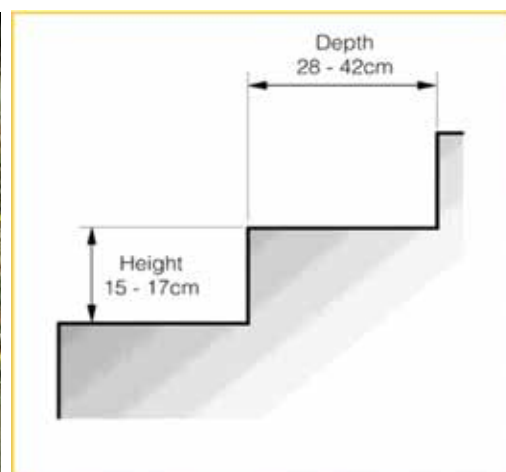

Construction	Advantages	Disadvantages	Improvements/ variations	Cost /labour
<p>Low concrete steps with cross-hatching to reduce the risk of slipping</p>	<p>Cross-hatching is easy to apply - the concrete is scored while wet</p>	<p>No edge protection for unstable or visually impaired users</p>	<p>Steps should be of consistent height</p> <p>Install a guard or handrail</p>	<p>Low/medium</p>
<p>Recommended step dimensions (for reference)</p> <p>Steps should be low and even - all of the same height and depth</p>	<p>Many users can manage low, even steps, especially when a handrail is provided</p> <p>Steps take up less space than a ramp</p>	<p>Steps exclude some users, e.g. those using mobility devices</p>	<p>Paint steps white or bright colour to increase visibility</p>	

Latrines

Household toilet design principles: For the household level, consider providing information about low cost, low tech options to make household latrines easier, more comfortable and safer for use by everyone in the family, especially disabled people.

Accessible design features could include:

- Level, marked paths. A firm, even path clear of hazards benefits everyone, not only wheelchair and crutch users
- Ramps or low steps with handrail to the latrine entrance
- Wide entrances to toilets, and enough space inside for a person and her/his carer to turn inside
- Simple handrails and movable toilet seats that can be placed over pit latrines
- Hand lever to replace a foot lever on 'tippy taps' for people with weak legs
- Toilets that are safe (location appropriate) and secure (e.g. lockable doors)
- Door handles and locks that can be easily reached by all

- Facilities for menstrual hygiene management, both at the household level and for institutional and public facilities

Sitting: Latrines should be no more than 15m from the household

Accessible Door & Entrance

- The doorway should have a clear width of 900mm for a person using wheelchair or those using assistants to get through.
- Door should generally open outside. Sliding doors are the most preferable.
- A distance of 450mm to 600mm beside and beyond the leading edge of the door and a safe landing space of 1200mm X 1200mm in front for a wheelchair user to manoeuvre.
- Door Handles should be fixed between 650 to 1100mm above the floor level. It should be preferably Lever shaped or D type handle.
- A 150mm long handle may be fixed on the outside.

The threshold of the toilet door should be at same level without any steps. No door seal or other trip hazard should be there.

Entrances

Entrances must be: a) wide enough (e.g for a wheelchair user it needs to be - wheelchair width + 20cm), and b) level enough (minimal or no difference between outside and inside).

It needs to be kept in mind that all people are not wheelchair users.

	Construction	Advantages	Improvements/ variations
	Latrine with level concrete entrance, wide enough for a wheelchair user	The floor of the latrine is the same level as the outside	Level flooring could be achieved with any type of materials, not only concrete

Doors

Suitable for: users with mobility devices, a helper, or carrying a small child, or people who are overweight.



Construction	Advantages	Disadvantages	Improvements/variatiions
Outward-opening tin door on wooden frame. Raised platform edge acts as a door stop	<p>Outward-opening door does not obstruct internal space</p> <p>Horizontal wooden struts can be grasped to close door</p>	<p>Pulling a door is harder than pushing it open</p> <p>Requires a wide, level area in front of door for users to position themselves to open the door</p>	<p>Add horizontal handrail</p>
Outward-opening wooden double doors with a latch on outside to keep closed	<p>Easier to close for some users</p> <p>Each door is narrow so less obstructive to passers by</p>	<p>Higher cost than a single door</p> <p>Some users find them difficult to use</p>	<p>Varnish/paint wood to reduce risk of termite damage</p> <p>Move bolt to the inside</p>

Door handles and closing mechanisms

Suitable: Suitable for everyone including women and girls. Latches are to be on the internal side of the doors

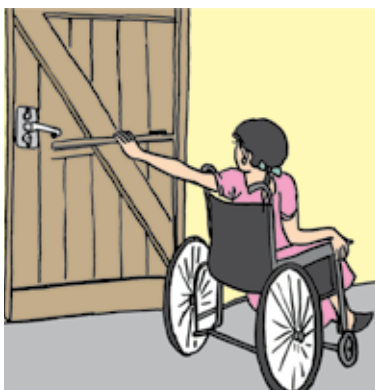

Construction	Advantages	Disadvantages	Improvements/variatioins
<p>Horizontal handrail the full width of the door on the inside. Internal bolt</p>	<ul style="list-style-type: none"> User can easily reach Door can be bolted to increase privacy Large, chunky bolt is easy to operate 	<ul style="list-style-type: none"> Door must be solid enough to fix the rail to Needs monitoring to ensure it is securely fixed and that the bolt slides easily 	<ul style="list-style-type: none"> Rail could be made of wood (2nd photo, left), GI pipe, chain, or cord
<p>Carved wooden handle nailed to the inside of the door</p>	<ul style="list-style-type: none"> Easy for all users to grasp Materials locally available Easy to construct 	<ul style="list-style-type: none"> Does not keep the door closed 	<ul style="list-style-type: none"> Add a bolt or hook to fasten the door closed Handle could also be fixed to the door frame for support when entering
<p>Metal hook and eye on inside of door</p>	<ul style="list-style-type: none"> Ensures privacy Easy to install Materials locally available 	<ul style="list-style-type: none"> Can be too fiddly for some users to operate 	<ul style="list-style-type: none"> Instead of a hook, wire can be looped over a bent nail, or a loop of string wound round a bent nail

Internal space

Consider: who will use the toilet, and how much space they will need.

Level 1: Space for users who can stand and enter using support rails, or blind users.

Level 2: Additional space for a carer, to use crutches/sticks or to park a wheelchair but not turn.

Level 3: Space for a wheelchair to enter, shut the door, and turn around inside.

Persons with disability using different types of assistive devices may require different space considerations for their safe and free movement. Persons with disability will require space of different dimensions when moving straight and

also when turning around using different types of assistive devices

- Ideal clear floor space of 2.0 mt X 1.8 mt (inner dimension) is required for a toilet having water closet. A wash basin can be fixed within this space.
- This space dimension will also be adequate for the wheelchair user. Minimum inner dimension of the room may be considered to be 1.8 mt X 1.5 mt in case of a Wheelchair User
- In case of persons who are using crutches or those who cannot walk comfortably, the dimension may be considered to be 1.5 mt X 1.2 mt. (inner dimension). In this case, the wash basin option in the toilet may be avoided. However, the water taps and the cistern can be easily fixed.

Seating

Fixed seat pan

Suitable for: people who have difficulty squatting, including overweight people, pregnant women, older people and disabled people.

In case of a Wheelchair user, the commode should be placed not in the middle space in the room. On one side, an unobstructed space of 900 mm from the edge of WC to the side wall should be provided and on the other side, the distance from the centre of the commode to the next adjacent wall should be 480 mm. There should be a clear space of 1200 mm in front of commode.

The top of commode may be fixed at a height of 475 to 490 mm from the floor or depend on the need and comfort of the user. In case of commode bought from the market, it is designed so. However, there are also modified/adapted toilets constructed with Indian type squatting pan depending on the type of disability and adaptation needs.

These modified options may be as the examples that follows:



Construction	Advantages	Disadvantages	Improvements/variatiions
Cement bowl made with mould	Comfortable Durable Easy to wipe, therefore hygienic	Requires a mould and is more difficult to construct Heavy, so needs a strong sanplat	Paint the seat to repel urine and make it easier to clean

Commode movable seats

Suitable for: people who have difficulty squatting, including overweight people, pregnant women, older people and disabled people.



Construction	Advantages	Disadvantages	Improvements/variatiions
<p>Painted wooden chair with 'potty' inserted in hole in seat. Potty is removed for emptying</p>	<p>Can be placed in the most convenient place for the user or carer, either inside or outside the house</p> <p>Fabric straps support a user with poor balance</p>	<p>Container must be emptied and cleaned after every use</p> <p>A separate private toilet area might need to be created</p> <p>Wood needs regular painting/varnishing</p>	<p>Padding can be added to back and sides for extra comfort</p> <p>Seat could be used without the potty, placed over the toilet hole</p> <p>A bucket could be used under the seat instead of a potty</p>
<p>Metal commode chair with plastic inset toilet pan (bought in local market)</p> <p>Container is placed beneath the seat and emptied into the latrine</p>	<p>Painted metal and plastic are strong, durable and easy to clean</p> <p>Can be placed in the most convenient place for the user or carer, either inside or outside the house</p>	<p>Container must be emptied and cleaned after every use</p> <p>A separate private toilet area might need to be created</p> <p>Metal for some users is uncomfortable - a home-made padded ring could be added for comfort</p> <p>Plank and waist belt added to provide extra support</p>	<p>Car tyre inner tube could also be used as a cushion</p>

Movable seats

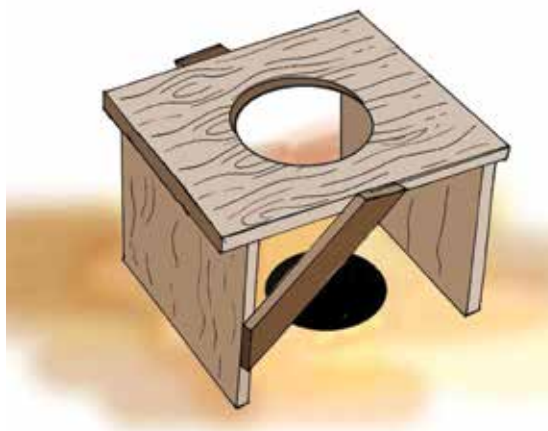

Construction	Advantages	Disadvantages	Improvements/variations
<p>Low wooden or bamboo toilet stool with hole in seat, placed over toilet hole, with or without funnel as a splash guard (see image)</p>	<ul style="list-style-type: none"> Easy to construct Materials available locally Height must be decided based on user's needs Can be moved to one side out of the way of other users who prefer to squat Light and easy to carry if necessary 	<ul style="list-style-type: none"> Potential for termite damage Enough space needed inside latrine to move the seat away from the pit when not in use Needs accurate positioning to reduce risk of splashing or soiling 	<ul style="list-style-type: none"> Painting or varnishing would make it more durable, easier to clean and more hygienic
<p>Standard varnished wooden chair with hole cut in the seat</p>	<ul style="list-style-type: none"> Comfortable Provides back support while seated Materials available locally Varnish makes chair easier to clean so more hygienic 	<ul style="list-style-type: none"> Needs extra space in the latrine so it can be moved to one side when not in use Might be heavy 	<ul style="list-style-type: none"> Add a splashguard to the front Add 'runners' - horizontal bars joining the bottom of the legs to better distribute the weight on the floor, to reduce damage (see image)

Hand Rails and Grab Bars

Hand Rails	Grab Bars
<p>Hand Rails provide support to the person with disability to hold and move forward along a ramp or stair and even along a straight pathway. The following are the specifications of hand rails:</p> <ul style="list-style-type: none">• There should be a clearance of at least 45mm from the adjacent wall/ surface to which it is fixed• Hand Rail should be fixed at two levels: one at 700mm-750mm and another at 850mm-900mm from the finished floor• It should be extended by at least 300mm beyond the head and foot of the flight and ramp <p>Hand Rails should be circular in section with diameter of 40 to 45mm</p>	<p>Grab Bars are supportive bars which may be of GI or steel pipes of 40 to 45mm diameter, fixed firmly to the adjacent walls and floors, so that persons with disability can transfer their body weight for movement.</p> <ul style="list-style-type: none">• For Wheelchair User - the movable grab bars (U type) are to be provided on transfer side at a height of 480mm from ground (i.e. at the same height as the commode). The L type bar should be fixed on the wall side to get adequate support during transferring the body weight• For others - it depends on the condition of disability and preference. Ideally, the bars should be provided on both sides on the wall and may be fixed to the floor on the transfer side. This may be of GI pipe and fixed, not movable. The grab bars may be fixed at a height between 450mm to 750mm or at a height as suitable to access and use• Sometimes, the grab bars are also fixed to the two adjacent walls close to commode

Hand Rails



Construction	Advantages	Disadvantages	Improvements/variations
Bricks protruding from wall for support to a weak or visually impaired person	<ul style="list-style-type: none"> Easy to construct Materials locally available 	<ul style="list-style-type: none"> Walls must be strong enough to support user's weight Difficult to add after construction Regular maintenance needed to ensure stability 	<ul style="list-style-type: none"> Half bricks in the wall can also provide mini-ledges for a user to hold on to
Wooden/ bamboo support rails fixed to floor either in front or on either side of toilet (depending on user's needs)	<ul style="list-style-type: none"> Materials locally available Easy to construct and maintain Allows user to transfer to the toilet from the side Position and height of rails must involve user and an assessment of their need 	<ul style="list-style-type: none"> Rails must be strong enough to bear users' weight Not possible to fix to a concrete floor/slab Might be difficult to keep clean Cannot fix to a concrete floor/slab 	<ul style="list-style-type: none"> Varnish/paint rail to stop termite damage and for easy cleaning For a growing child use longer vertical poles, so bar height is adjustable Horizontal bars at different heights might suit some For concrete floors, pipe rails can be cemented in during construction, or screwed to floor later
Metal bars (e.g. galvanised iron pipe) fixed to side wall/s of latrine	<ul style="list-style-type: none"> Highly durable Can be added to existing facility Easy to clean Bars to be positioned based on user needs 	<ul style="list-style-type: none"> Walls must be strong enough to fix bars to Walls must be close enough for user to reach the bars 	<ul style="list-style-type: none"> Paint bars to reduce corrosion and increase durability Several bars at different heights on each side might better suit some users

3. Accessible design options with cost-working models

Planners and service providers need to consult people with disabilities at all stages of project cycle by design. It has been proven that designs developed with user feedback not only results in constructing user friendly WASH facilities but also have a higher acceptance/ usage. People with disabilities and members from the marginalised/ excluded group can play an effective role in WASH committees and in managing community WASH facilities. The models shared here have

been constructed in Jharkhand and Odisha with community engagement and are examples for reference. There can be better and improved options that can be designed.

*It may be mentioned here that these examples / models have been constructed in 2013 and the costs are as per the prevailing market rates at that time in that specific state. This will vary from as per the current market rates in different states and geographies. The disability accessible adaptations are in bold.

Do's and Dont's for Accessible Sanitation Facilities for Persons with Disabilities

Do's

1. Provide an access ramp that is firm and smooth for wheelchairs as well as ambulant-disabled without wheelchairs
2. Ramp should be wide enough to accommodate a wheelchair
3. Landings or flat surfaces should have an area large enough to permit wheelchair to turn
4. Steps can be used if the household does not have permanently disabled people. These must conform to the norms provided in this handbook
5. Doors to sanitation facilities should be at least the width of a wheelchair and open outwards. The minimum width is 90 cm
6. String or other means of opening from outside must be provided that is accessible while seated in a wheelchair
7. Entrance area should be flat i.e., have a landing before the door so wheelchair users can leave the chair while entering the facility

8. Slope should be as per the norms given in this handbook
9. Toilet should be large enough to accommodate wheelchair and allow disabled user freedom of movement
10. Assessment of physically challenged people in household must be done before designing the toilet
11. Disabled people must be brought together to discuss their specific needs at the planning stage. This may not happen if a general meeting on sanitation is held in the community
12. While planning, households with disabled people can be marked with a different colour on a map
13. The disabled person(s) in a household must be consulted before designing the toilet or bathroom. This will help understand the barriers and determine the best model
14. Water supply in the toilet must be accessible to the visually and ambulant disabled

15. For visually challenged, contrasting colours must be used on the access, railings and inside

16. For visually challenged, tactile cues are necessary on the railing outside and the support bars inside the toilet

17. Guideposts with tactile cues painted in bright colours are necessary to guide visually challenged from home to the toilet

18. Local materials must be used to reduce costs. Bamboo, wood or steel may be used instead of cement where appropriate and available

19. Training to masons must be provided on constructing ramps for ambulant-disabled and tactile strips to visually disabled

20. Access to toilet must be kept free of shrubbery and other overgrowth and must be no more than 15 m from the house

21. Water bucket or pot must be kept at a height that is convenient ?

Don'ts

1. Don't make steps on the access ramp. If needed for non-disabled access, steps to the toilet must be provided separately
2. Don't rearrange the toilet so it is unfamiliar to visually challenged people
3. Don't leave extra buckets, mugs or other things in the toilet
4. Don't place locks or latches for the door at the top where ambulant-disabled cannot reach
5. Don't have sharp edges or corners on guideposts, railings and inside the bathroom or on the way
6. Don't provide loose ramps that can be moved while being used
7. Steps must not exceed measurements provided in this handbook
8. Don't keep water source on the ground where it is hard to reach and use
9. Don't have one type of seat - allow the user to decide if a fixed or moveable seat is preferable
10. Don't have a heavy door that is hard to open

Model 1

Name: Kedar Sethi
 Place: Tentulidihi, Odisha
 Type of Disability: Physical Impairment (Polio)
 Disability friendly options:
 (Approach road, Hand rail, Grab bar, commode as WC)

The approach is provided with smooth & wide path with hand rails fixed at 750mm height of bamboo and inside the commode from market is bought and fixed. At both sides GI grab bars are fixed one side to the wall and other to the floor. A small tank is attached to the toilet where water is stored manually and can flow through the tap connections made in the toilet.



IHHL of Kedar Sethi, Tentulidihi
 Total cost * **11,190**

Inclusive toilet of Kedar Sethi

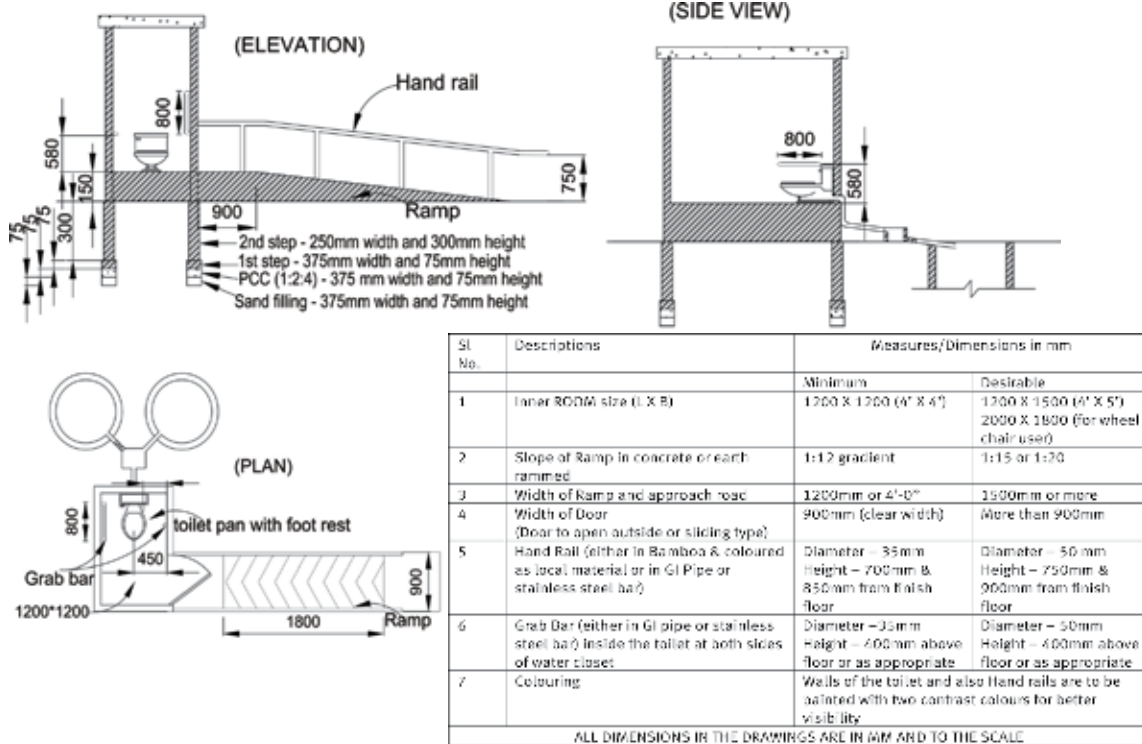

* The cost of toilet can vary depending on the prevailing market rates at that time in that specific state.

Model 2

Name: Jitendra Turi
 Place: Sirsanunthar in Deoghar district
 Type of Disability: Multiple (mental disability, blind)
 Disability accessible options—
 (Ramp, Hand rail, Grab bar, painting, modified WC)

The boy has mental retardation and also fully blind. So approach road is prepared with compacted earth fill and bamboo railing is put at the side so that he can access the toilet. Inside the toilet the seat height is raised with brick masonry and pan is fixed over it. GI grab bars are fixed to the walls.



IHHL of Jitendra Turi, Deoghar
Total Cost* 10,900

Inclusive toilet of Jitendra Turi

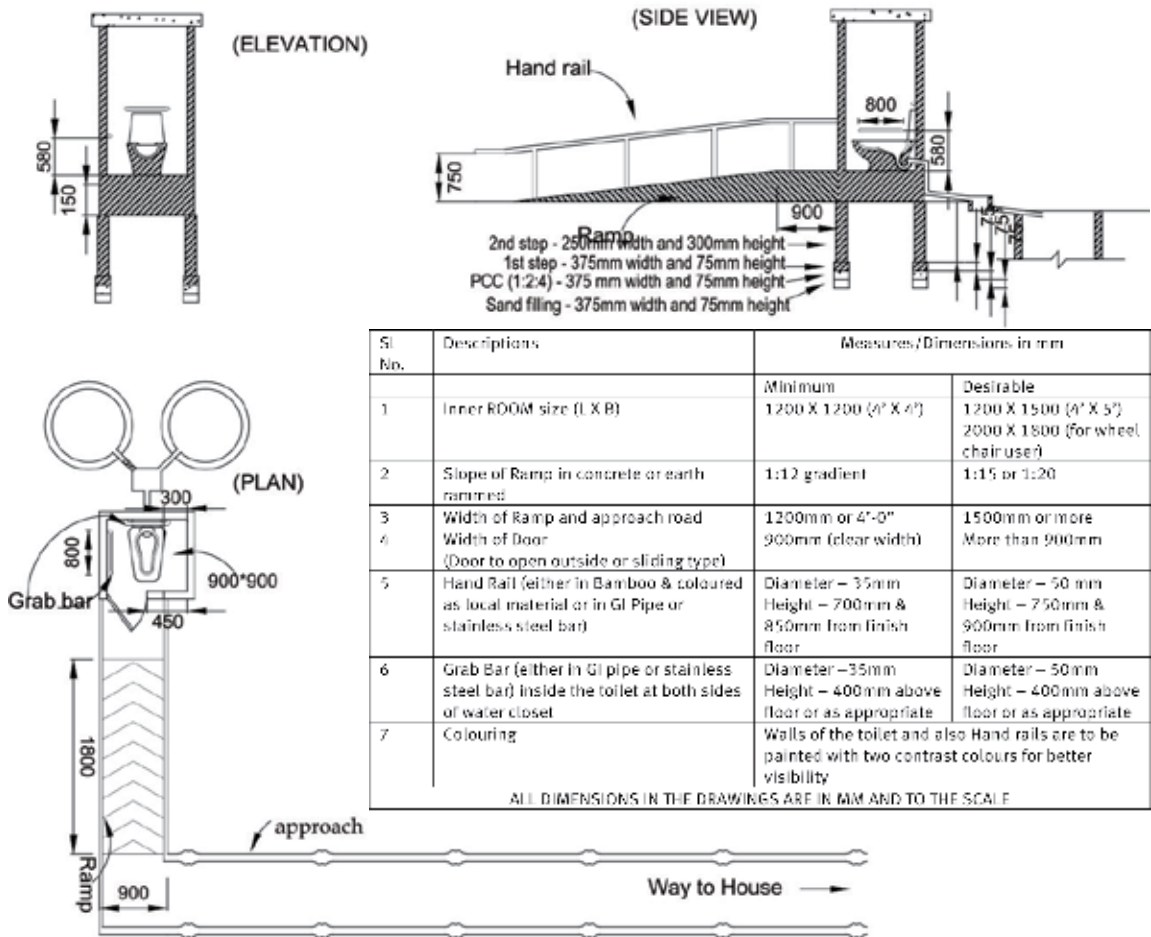

* The cost of toilet can vary depending on the prevailing market rates at that time in that specific state.

Model 3

Name: Rohit Mandal

Place: Jogia Village in Deoghar district

Type of Disability: Visual and locomotor disability

Disability Friendly Options:

(Ramp, Hand rail, Grab bar, painting, modified brick masonry WC)

Access to the toilet is a cemented ramp of 1:12 slope with bamboo hand rails fixed at 650mm height. The toilet inside is space of 4'-6" X 4'-6" size with modified brick masonry commode with space to put legs at both sides. Commode is at a height of 400mm and grab bars in 25mm GI pipe is fixed to the walls.



IHHL of Rohit Mandal, Jogia Village, Deoghar
Total Cost * 11,000

Inclusive toilet of Rohit Mandal

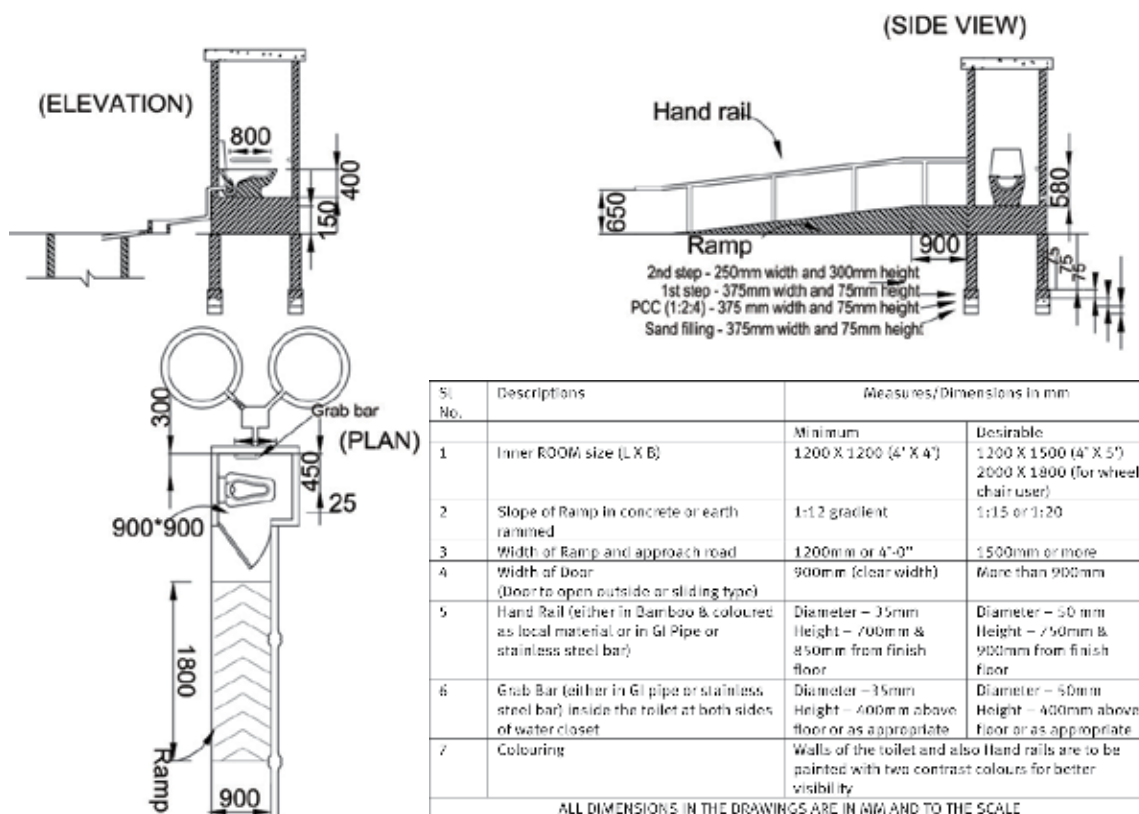

* The cost of toilet can vary depending on the prevailing market rates at that time in that specific state.

Model 4

Name: Kalicharan Kisku

Village: Bogli in Dumka, Jharkhand

Type of Disability: Visual Impairment (partial blindness)

Disability Friendly Options: Bamboo Hand rail, GI Grab bar, contrast colour

The person is visually impaired. Handrails support him to the toilet and the bright coloured helps him to see.

IHHL of Kalicharan Kisku
Total cost* 8,560



Inclusive toilet of Kalicharan Kisku

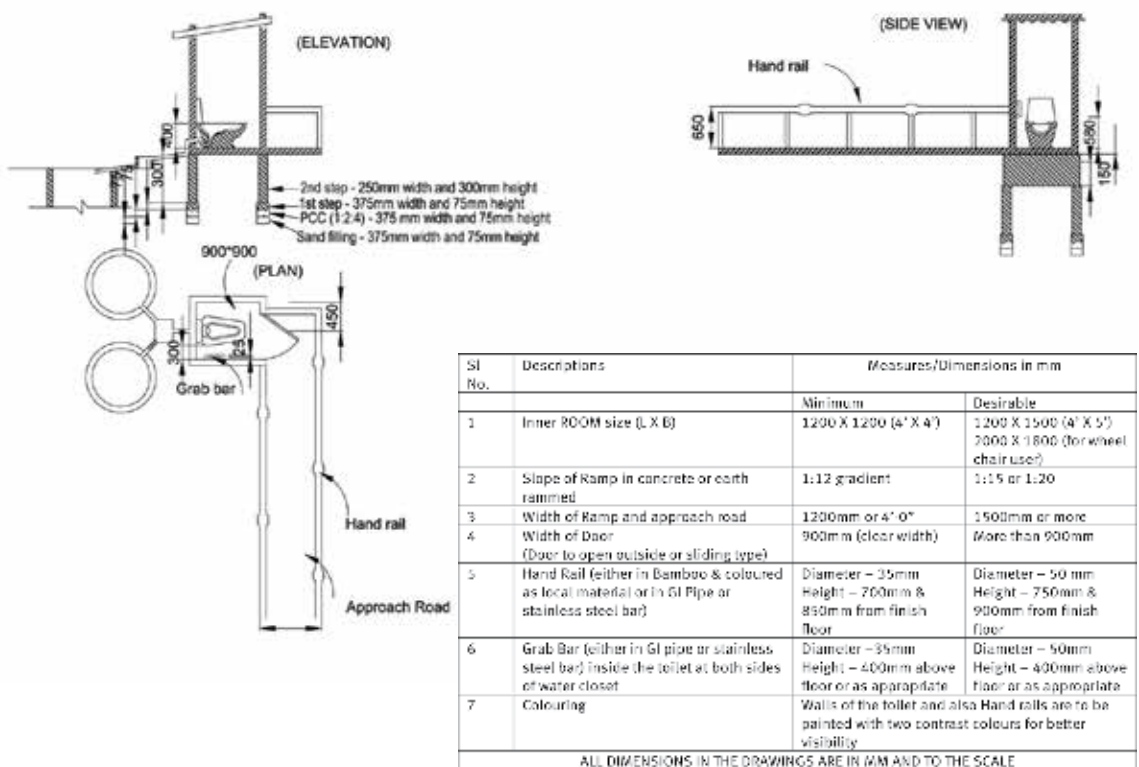

* The cost of toilet can vary depending on the prevailing market rates at that time in that specific state.

Model 5

Name: Pintu Paswan

Place: Prandi in Deoghar district

Type of Disability: Physical disability (Polio)

Disability friendly Options: The toilet was constructed earlier.

The plastic chair was cut to appropriate height and a hole is made at center. The chair is removed after Pintu uses the toilet so that other family members can use the toilet.



IHHL of Pintu Paswan

Total cost* 9,100

Inclusive toilet of Pintu Paswan

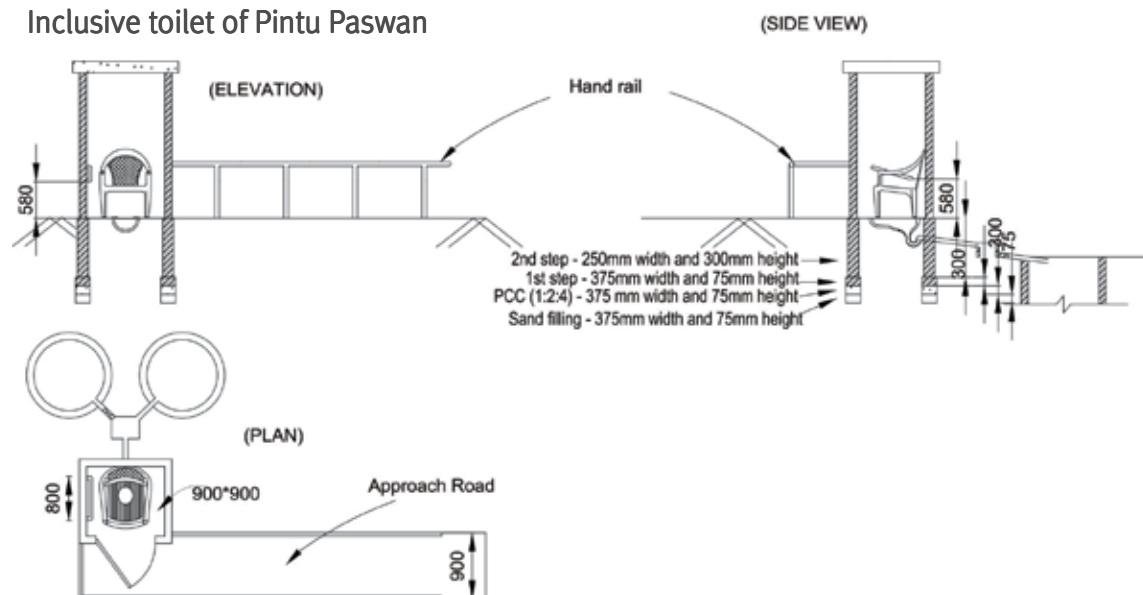

Sl No.	Descriptions	Measures/Dimensions in mm	
		Minimum	Desirable
1	Inner ROOM size (L X B)	1200 X 1200 (4' X 4')	1200 X 1500 (4' X 5') 2000 X 1800 (for wheel chair user)
2	Slope of Ramp in concrete or earth rammed	1:12 gradient	1:15 or 1:20
3	Width of Ramp and approach road	1200mm or 4'-0"	1500mm or more
4	Width of Door (Door to open outside or sliding type)	900mm (clear width)	More than 900mm
5	Hand Rail (either in Bamboo & coloured as local material or in GI Pipe or stainless steel bar)	Diameter – 35mm Height – 700mm & 850mm from finish floor	Diameter – 50 mm Height – 750mm & 900mm from finish floor
6	Grab Bar (either in GI pipe or stainless steel bar) inside the toilet at both sides of water closet	Diameter – 35mm Height – 400mm above floor or as appropriate	Diameter – 50mm Height – 400mm above floor or as appropriate
7	Colouring	Walls of the toilet and also Hand rails are to be painted with two contrast colours for better visibility	

ALL DIMENSIONS IN THE DRAWINGS ARE IN MM AND TO THE SCALE

* The cost of toilet can vary depending on the prevailing market rates at that time in that specific state.

Model 6

Name: Manoj Pandit
 Place: Khodkuan in Deoghar district
 Type of Disability: Physical Impairment
 Disability friendly Options: (GI Grab Bar, wooden stool)



The toilet was constructed earlier.

The wooden stool with a hole in the middle is of 320 mm height as appropriate for use by Manoj and after his use the stool is removed and kept outside so that other family members can use the same toilet without the stool. The grab bars are fixed to the walls in appropriate heights so that Manoj can hold and sit down or get up.



Here a wooden stool is used but one can use a plastic stool or a fibre stool as well or cut a hole in a chair for use depending on convenience, availability and safety.

IHHL of Manoj Pandit
 Total cost* 9,425

Inclusive toilet of Manoj Pandit

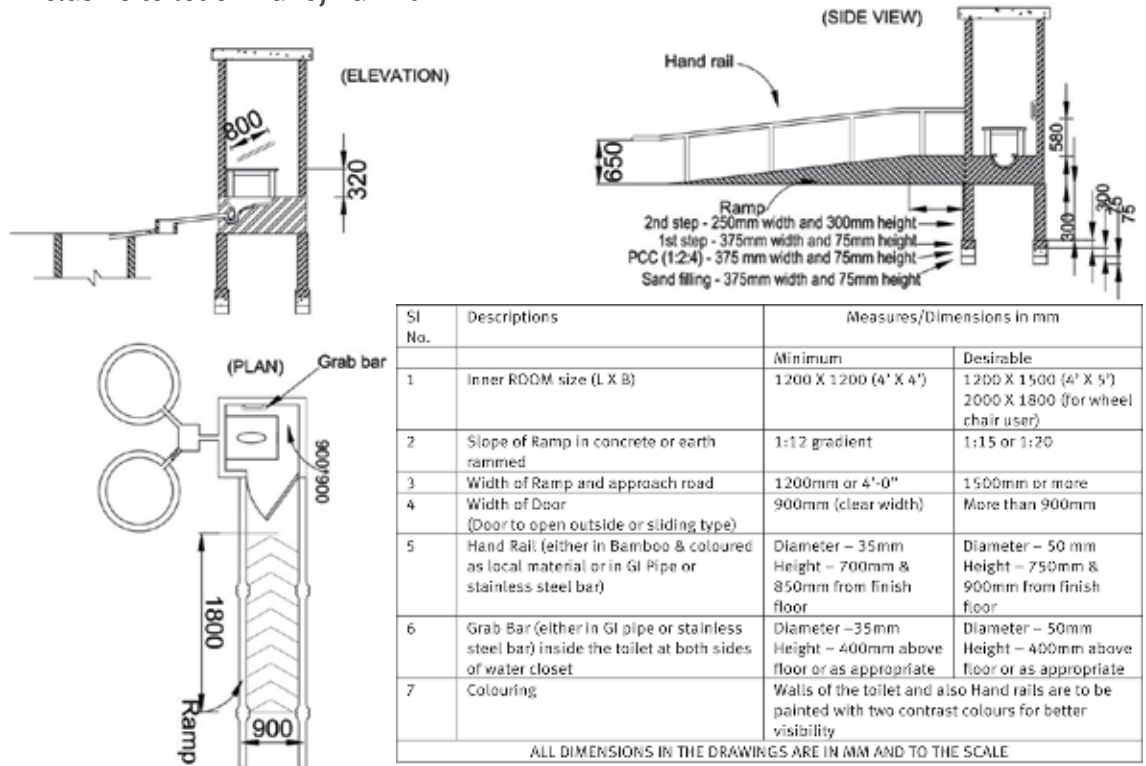

* The cost of toilet can vary depending on the prevailing market rates at that time in that specific state.

Model 7

Name: Debu Tatwa
 Place: Pachrodihi in Dumka district
 Type of Disability: Physical Impairment (Paralysis)
 Disability friendly Options: (approach road, hand rail, GI Grab Bar, GI frame stool)

The approach road is constructed in cement mortar and hand rails are fixed in bamboo at both sides and GI framed WC sheet is fixed at 350mm height which can be used and lifted afterwards. The grab bars are L shaped using 25mm GI pipes.



IHHL of Debu Tatwa
Total cost* 11,225

Inclusive toilet of Debu Tatwa

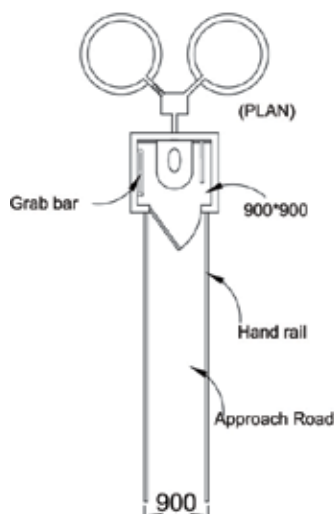
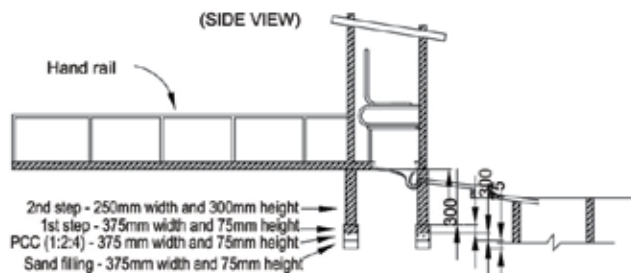
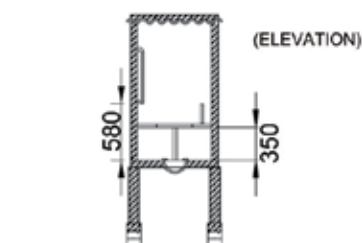

Sl No.	Descriptions	Measures/Dimensions in mm	
		Minimum	Desirable
1	Inner ROOM size (L X B)	1200 X 1200 (4' X 4')	1200 X 1500 (4' X 5') 2000 X 1800 (for wheel chair user)
2	Slope of Ramp in concrete or earth rammed	1:12 gradient	1:15 or 1:20
3	Width of Ramp and approach road	1200mm or 4'-0"	1500mm or more
4	Width of Door (Door to open outside or sliding type)	900mm (clear width)	More than 900mm
5	Hand Rail (either in Bamboo & coloured as local material or in GI Pipe or stainless steel bar)	Diameter – 35mm Height – 700mm & 850mm from finish floor	Diameter – 50 mm Height – 750mm & 900mm from finish floor
6	Grab Bar (either in GI pipe or stainless steel bar) inside the toilet at both sides of water closet	Diameter – 35mm Height – 400mm above floor or as appropriate	Diameter – 50mm Height – 400mm above floor or as appropriate
7	Colouring	Walls of the toilet and also Hand rails are to be painted with two contrast colours for better visibility	

ALL DIMENSIONS IN THE DRAWINGS ARE IN MM AND TO THE SCALE

* The cost of toilet can vary depending on the prevailing market rates at that time in that specific state.

References:

1. Adapted from: Compendium of accessible WASH technologies Hazel Jones and Jane Wilbur (2014)
2. Adapted from: Frontiers of CLTS series - Disability: Making CLTS Fully Inclusive, Jane Wilbur for WaterAid and Hazel Jones for WEDC July 2014 (IDS, SHARE, WaterAid, DFID)
3. Briefing Note: Including disabled people in sanitation and hygiene services, June 2011 by Guy Collender, SHARE, Jane Wilbur, WaterAid, Louisa Gosling, WaterAid





सत्यमेव जयते

**MINISTRY OF DRINKING WATER AND SANITATION
GOVERNMENT OF INDIA**

Ministry of Drinking Water and Sanitation
Government of India
C Wing, 4th floor Paryavaran Bhawan,
CGO Complex Lodhi Road,
New Delhi – 110003



WaterAid

WaterAid's mission is to transform the lives of the poorest and most marginalised people by improving access to safe water, sanitation and hygiene.

WaterAid India – Country Office

403, 4th Floor, CNI Bhavan, 16 Pandit Pant Marg,
New Delhi -11 0 001 (India)
Tel: +91-11-4608 4400 Fax: +91-11-4608 4411
Email: waindia@wateraid.org

www.wateraidindia.in

WaterAidIndia WaterAidIndia